



Astris 3K/5K/6K

Installation Manual
(Hardware)

SIN110030001ATCU0B - Astris 3K/1P1T1
SIN120040002ATCU0B - Astris 4K/1P2T2
SIN120050002ATCU0B - Astris 5K/1P2T2
SIN120060002ATCU0B - Astris 6K/1P2T2

Manual de Instalare
(Hardware)



316.33.23.0

Contents

Safety	2
1.1 Personnel Safety	2
1.2 PV Inverter Protection	3
1.3 Installation Safety	3
1.4 Electrical Connections	3
1.5 Operating and Commissioning	4
1.6 Maintenance	4
1.7 Additional Information	5
Overview of the Inverter	5
2.1 Functional Models	5
2.2 Network Application	6
2.3 Outline and Dimensions	6
2.4 Working Process	8
2.5 Working Modes	9
Storage	10
Installation	11
4.1 Checking the Outer Packing	11
4.2 Moving the inverter	12
4.3 Identify the PV Inverter	12
4.4 Installation Requirements	13
4.5 Installing a Rear Panel	17
4.6 Installing the inverter	20
Electrical Connections	21
5.1 Connecting Protection Ground (PGND) Cables	21
5.2 Connecting AC Output Cables	23
5.3 Connecting the PV Strings	26
5.4 Connecting Communication Cables	31
5.5 Power limit (optional)	32
5.6 Installation Verification	34
5.7. Parallel inverter mounting	35
System Operation	35
6.1 Powering ON the Inverter	35
6.2 Powering OFF the Inverter	35
User Interface	36
7.1 HMI specification definition	37

7.2 LCD automatic-page-turning display	38
Maintenance	39
8.1 Routine Maintenance	39
8.2 Inverter Troubleshooting	41
8.3 Removing the Inverter	43

Forward

Please read this manual before using the product.

This user manual introduces the inverter in terms of its installation, electrical connections, operation, commissioning, maintenance, and troubleshooting. Please read through the manual carefully before installing and using the inverter, and keep the manual well for future reference.

Application Model

Grid-tied PV string inverter

- 3K/5K/6K

Applicable Personnel







This user manual is intended for photovoltaic (PV) inverter operating personnel and qualified electrical technicians.

NOTE!

This user manual is subject to change without prior notice.

Symbol Conventions

Safety symbols used in this manual, which highlight potential safety risks and important safety information, are listed as follows:

Symbol	Description
 DANGER	Indicates an imminently hazardous situation which, if not correctly followed, will result in serious injury or death.
 WARNING	Indicates a potentially hazardous situation which, if not correctly followed, could result in serious injury or death.
 CAUTION	Indicates a potentially hazardous situation which, if not correctly followed, could result in moderate or minor injury.
 NOTICE	Indicates a potentially hazardous situation which, if not correctly followed, could result in equipment failure, or property damage.
 NOTE	Calls attention to important information, best practices and tips: supplement additional safety instructions for your better use of the PV inverter to reduce the waste of your resource.
 REFER	Refer to documentation (Remind operators to refer to the documentation shipped with the inverter).

1 Safety

Before beginning your journey, please read these safety precautions in User Manual carefully.

1.1 Personnel Safety

- The PV inverter must be installed, electronically connected, operated and maintained through specially trained technician;
- The qualified technician must be familiar with the safety regulations of electrical system working process of PV power generation system, and standards of local power grid;
- The technician must read through this User Manual carefully and master it before any operation.

1.2 PV Inverter Protection

NOTE!

As soon as receiving the PV inverter, please check if it is damaged during its transportation. If yes, please contact your dealer immediately.

- a. Do not tamper with any warning signs on the inverter enclosure because these signs contain important information about safe operation.
- b. Do not remove or damage the nameplate on the inverter's enclosure because it contains important product information.

1.3 Installation Safety

NOTE!

Please read the User Manual carefully before installing the PV inverter; warranty or liability will be void from our company if damage is caused by installation faults.

- a. Ensure there is no electrical connections around ports of the PV inverter before installing;
- b. Adequate ventilation must be provided for inverter installation location. Mount the inverter in vertical direction, and ensure that no object is put on the heat sink affecting the cooling. (For details, refer to Chapter 4 Installation).

1.4 Electrical Connections



DANGER

Before installing the inverter, check all electrical ports to ensure no damage and no short circuit. Otherwise personal casualty and/or fire will occur.

- a. Input terminals of the PV inverter apply only to input terminals of PV String; do not connect any other DC source to the input terminals.
- b. Before connecting PV modules, ensure that its voltage is within the safe range; when exposed to any sunlight, PV modules can generate high voltage.
- c. All electrical connections must meet the electrical standards of the country or region.

d. Cables used in electrical connections must be well fixed, good insulation, and with appropriate specification.

1.5 Operating and Commissioning

DANGER

While the inverter operating, high voltage can lead to an electrical shock hazard, and even cause personal casualties. Therefore, operate the PV inverter strictly according to the safety precautions in the user manual.

WARNING

When the photovoltaic array is exposed to light, it supplies a DC voltage to the PCE.

- Before getting the permission of electrical power authority in the country/region, the grid-tied PV inverter cannot start generate power.
- Follow the procedures of commissioning described in the user manual when commissioning the PV inverter.
- Do not touch any other parts'surface except the DC switch when the PV inverter is operating; its partial parts will be extremely hot and can cause burns.

1.6 Maintenance

DANGER

Power OFF all electrical terminals before the inverter maintenance; strictly comply with the safety precautions in this document when operating the inverter.

- For personal safety, maintenance personnel must wear appropriate personal protective equipment (like insulation gloves and protective shoes) for the inverter maintenance.

- b. Place temporary warning signs or erect fences to prevent unauthorized access to the maintenance site.
- c. Follow the procedures of maintenance stipulated in the manual strictly.
- d. Check the relevant safety and performance of the inverter; rectify any faults that may compromise the inverter security performance before restarting the inverter.

1.7 Additional Information

NOTE!

To avoid any other unforeseeable risk, contact your dealer immediately, if there is any issue found during operation.

2 Overview of the Inverter

This chapter introduces the inverter and describes its functional model, network application, appearance, dimensions, and working process etc.

2.1 Functional Models

2.1.1 Function

This series is a single-phase grid-tied PV string inverter (transformer less) that converts the DC power generated by PV strings into AC power and feeds the power into power grid.

WARNING

The inverter is transformerless. Add an isolation transformer before grounding the positive/ negative terminal of PV modules (like Thin Film module) for operation.

WARNING

Do not connect PV modules in parallel to several PV inverters for operation.

2.1.2 Model Description

Figure 2.1 shows a model number of the inverter, using 3K and 5K/6K as an example.

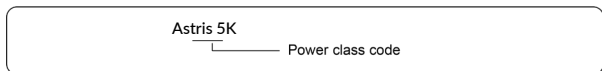

Figure 2.1 Model number descriptions

2.2 Network Application

2.2.1 Grid-tied PV Power Systems

The series applies to grid-tied PV power systems for outdoor power stations. Typically, a grid-tied PV power system consists of PV modules, grid-tied inverters, AC distribution units, and low-voltage power grid, as shown in **Figure 2.2**.

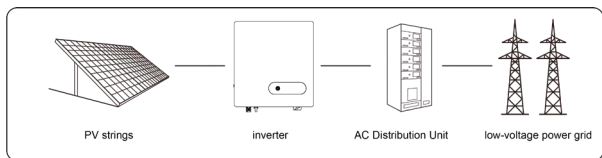

Figure 2.2 a low-voltage grid-tied PV power system

2.3 Outline and Dimensions

2.3.1 Outline

Figures 2.3 to 2.7 show the outline of the inverters as follows:

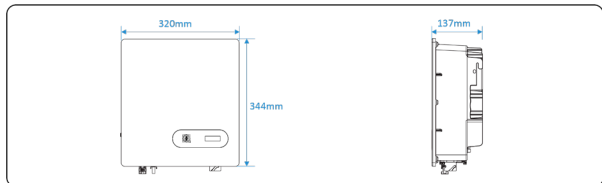

Figure 2.3 - 3K PV Inverter with Single MPPT Input (unit: mm)

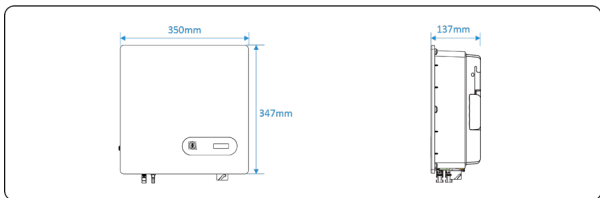

Figure 2.4 - 5K/6K PV Inverter with Dual MPPT Input (unit: mm)

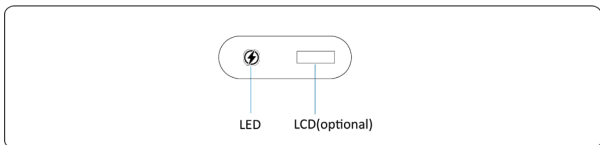

Figure 2.5 The front view and amplification effect of LED indicator area

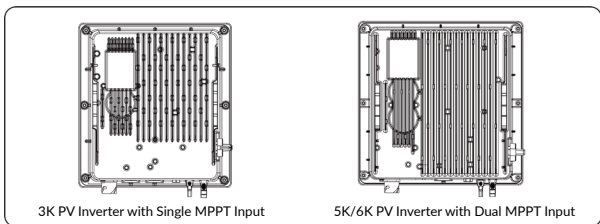

Figure 2.6 The rear view of this series of inverter

1. PV input connectors
2. COM2(RS-485/meter/CT/DI)
3. COM1(WIFI/GPRS/Ethernet/ RS-485)
4. AC output connector
5. External protect
6. Vent valve
7. DC isola

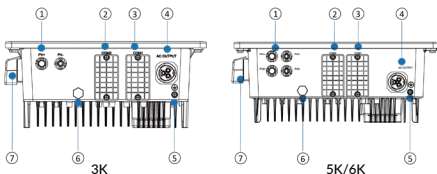

Figure 2.7 The bottom view of this series of inverter

2.4 Working Process

2.4.1 Basic principle Description

The 5K/6K PV Inverter with Dual MPPT Input receives input from two strings of PV panel (3K PV Inverter with Single MPPT Input receives input from only one string of PV panel). Then the inputs are grouped into two independent MPPT routes inside the inverter to track the maximum power point of the PV panel. The two MPPT power is then converted into DC Bus, then the DC power is converted to AC power through an inverter circuit. Finally the AC power is fed to the Power grid. EMI filter is used on both the DC and AC sides to reduce the electromagnetic inference; Surge protection is supported on AC side.

2.4.2 Circuit Diagrams

Figure 2.8 shows the circuit diagram for the 3K PV Inverter with Single MPPT Input:

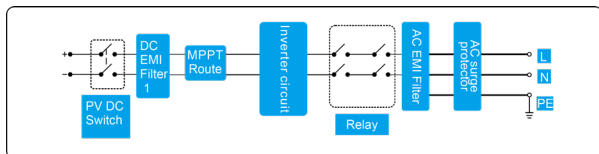

Figure 2.8 circuit diagram

Figure 2.9 shows the circuit diagram for the 5K/6K Inverter with Dual MPPT Input:

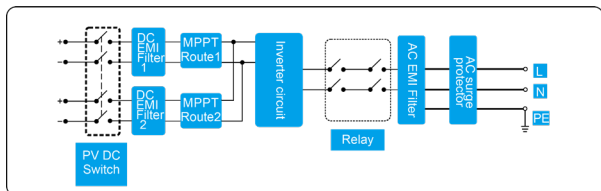

Figure 2.9 circuit diagram

2.5 Working Modes

Three working modes of the inverter are shown as follows: standby, operating, and shutdown.

Table 2.1 shows the conditions for the inverter to switch between working modes.

Modes	Description
Standby	<p>The PV inverter enters the standby mode when</p> <ul style="list-style-type: none"> >the input voltage of PV Strings can enable auxiliary power supply to run, but cannot meet the inverter operation requirements. >the input voltage of PV Strings can meet the inverter to-start requirements, but cannot meet its minimum power requirements.
Operating	<p>When the PV inverter is grid-tied and generates electricity, it</p> <ul style="list-style-type: none"> > tracks the maximum power point to maximize the PV String output. > converts DC power from PV strings into AC power and feeds the power to the power grid. <p>The PV inverter will enter to the shutdown mode if detecting a fault or a shutdown command.</p>
Shutdown	<p>The PV inverter switches from standby or operating mode to shutdown mode if detecting a fault or a shutdown command.</p> <p>The inverter switches from shutdown mode to standby mode if receiving a Startup command or detecting that a fault is rectified.</p>

Table 2.1 Working modes description

NOTE!

instructions: if the equipment is used in a manner not specified by the manufacturer, the protection provided by the equipment may be impaired.

3 Storage

This chapter describes the storage requirements for the inverter.

The following storage instructions apply if the PV inverter will not be deployed immediately:

- > Do not unpack the inverter (put desiccant in the original box if the PV inverter is unpacked).
- > Store the PV inverter at a temperature range of -25°C to +60°C and with the relative humidity of 0% to 100% (no condensing).
- > The PV inverter should be stored in a clean and dry place and be protected from dust and water vapor corrosion.
- > 3K PV Inverter with Single MPPT Input a maximum of eight layers of inverters can be stacked, 5K/6K PV Inverter with Dual MPPT Input a maximum of six layers of inverters can be stacked.
- > Do not position the inverter at a front tilt, excessive back tilt, or side tilt, or upside down.
- > Conduct periodic inspection during storage. Replace the packing materials immediately if any rodent bites are found.
- > Ensure that qualified personnel inspect and test the inverter before use if it has been stored for a long time.

4 Installation

DANGER

Do not install the inverter on flammable building materials or in an area where flammable or explosive materials are stored.

CAUTION

Do not install the inverter in a place where personnel are likely to come into contact with its enclosure and heat sinks to avoid electrical shock/burn.

4.1 Checking the Outer Packing

- When receiving the inverter, check that the packing materials are intact.
- After unpacking, check that the deliverables are complete, intact, and consistent with your order list.
- Examine the PV inverter and its fittings for damage such as scraps and cracks.

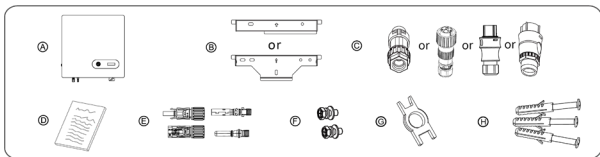

Items	Deliverables
A	The inverter
B	Rear panel
C	AC output connector
D	File package
E	DC terminal connector group
F	Screws
G	Removal tool for DC connector
H	Expansion screw group (reserved for tightening the support and rear panel)

Figures 4.1 The deliverables: The inverter and its fittings

NOTE!

If any damage mentioned above is found, contact the dealer immediately.

NOTE!

PV modules for non-isolated inverters. Non-isolated inverters shall be provided with installation instructions that require PV modules that have an IEC 61730 Class A rating. If the maximum AC mains operating voltage is higher than the PV array maximum system voltage then the instructions shall require PV modules that have a maximum system voltage rating based upon the AC mains voltage.

4.2 Moving the inverter

After checking the outer packing, move the PV inverter to the designated installation position horizontally. Hold the handles on both sides of the inverter, as shown in **Figure 4.2**.

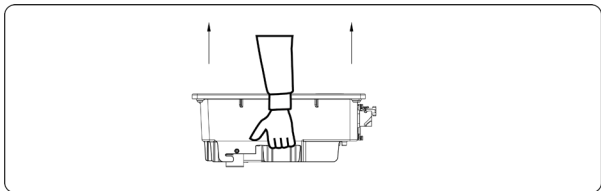

Figure 4.2 Moving the inverter



CAUTION





- >Do not place the PV inverter with its wiring terminals contacting the floor because the power ports and signal ports at the bottom of the device are not designed to support the weight of the inverter.
- >When placing the inverter on the floor horizontally, put foam or paper under to protect its enclosure.

4.3 Identify the PV Inverter

4.3.1 Nameplate

After moving the PV inverter from packing box, identify it by reading its nameplate labeled on the side of the inverter. The nameplate contains important product information: the model information, communications/technical specifications, and compliance symbols.

4.3.2 Compliance and Safety Symbols

Safety symbol	Description
	Electrical shock! There are residual voltages in the PV inverter. It needs 5 minutes to finish discharge.
	The PV inverter must not be touched when in operation. Its enclosure and heat sinks are extremely hot.
	Electrical shock! This part is charged. Only qualified and/or trained electrical technicians are allowed to perform operations on the inverter.
	If the inverter service life has expired, dispose it in accordance with local rules for disposal of electrical equipment waste. Do not dispose the PV inverter with household garbage.
	The PV inverter is compliant with TUV.

4.4 Installation Requirements

Applies to wall-mounting installation, as described below in detail.

4.4.1 Determining the Installation Position

Basic Requirements

- The inverter is protected to IP65 and can be installed indoors or outdoors.
- The installation method and position must be appropriate for the weight and dimensions of the inverter.
- Do not install the inverter in a place where personnel are likely to come into contact with its enclosure and heat sinks because these parts are extremely hot during operation.
- Do not install the inverter in an area that stores flammable or explosive materials.

Installation Environment Requirements

- The ambient temperature must be below 50°C to ensure the inverter's optimal operation and extend its service life.
- The inverter must be installed in a well ventilated environment to ensure good heat dissipation.
- The inverter must be free from direct exposure to sunlight, rain, and snow to extend its service life. It is recommended that the inverter be installed in a sheltered place. If no shelter is available, build an awning, as shown in **Figure 4.3**.

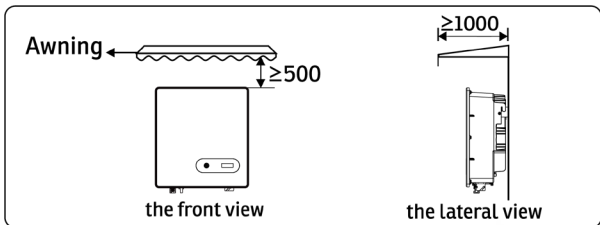

Figures 4.3 Installation environment with awning (unit: mm)

Carrier Requirements

- The carrier where the inverter is installed must be fire-proof. Do not install the inverter on flammable building materials.
- The wall must be solid enough to bear the weight of the inverter.
- Do not install the inverter on a wall made of gypsum boards or similar materials with weak sound insulation to avoid noise disturbance in a residential area.

Installation Space Requirements

- It is recommended that the inverter be installed at eye level to facilitate operation and maintenance.
- Reserve enough clearance around the inverter to ensure sufficient space for installation and heat dissipation, as shown in **Figure 4.4**.

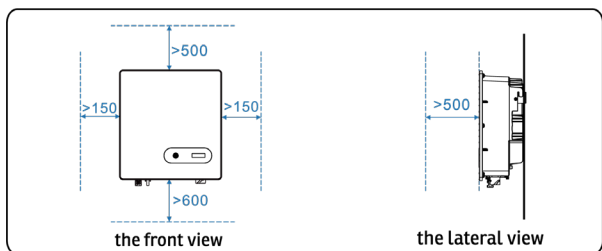

Figures 4.4 Installation Space Requirements (unit: mm)

c. When installing multiple inverter, install them along the same line (as shown in **Figure 4.5**) if sufficient space is available, and install them in triangle mode (as shown in **Figure 4.6**) or in stacked mode (as shown in **Figure 4.7**) if no sufficient space is available. The installation modes ensure sufficient space for installation and heat dissipation.

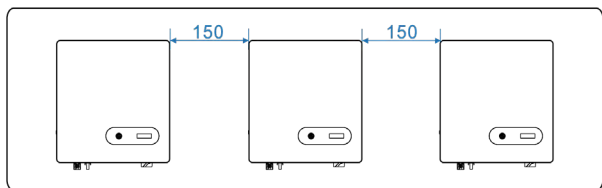

Figure 4.5 Installation along the same line (unit: mm)

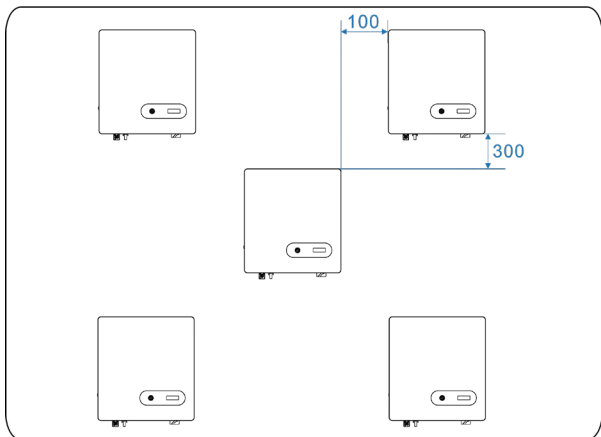

Figure 4.6 Installation in triangle mode (unit: mm)

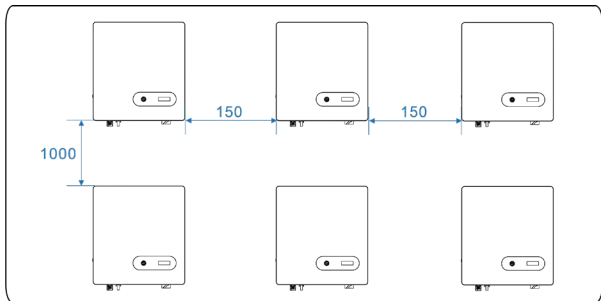

Figure 4.7 Installation in stacked mode (unit: mm)

NOTE!

The clearance between multiple inverters must be increased to ensure proper heat dissipation when they are installed in a hot area.

4.4.2 Installation Mode Requirements

Install the inverter upright or at a maximum back tilt of 15 degrees to facilitate heat dissipation. Some correct / wrong installation modes are shown in **Figures 4.8&4.9** below.

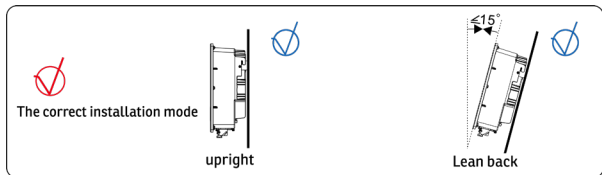

Figures 4.8 The correct installation mode

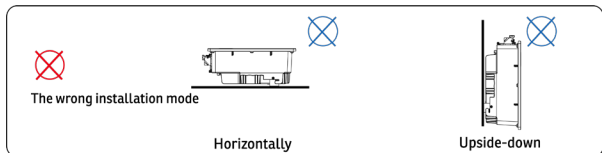

Figures 4.9 The wrong installation modes

NOTE!

The wrong installation will lead to failure of the inverter operation.

4.5 Installing a Rear Panel

Before installing the inverter, secure the rear panel to a wall.

Step 1 Move out the rear panel from the packing case.

Step 2 Determine the positions for drilling holes (as shown in **Figure 4.10**) using the rear panel.

NOTE!

The recommended 5K/6K inverter rear panel mounting combination is hole 1, 4 or 2, 3.

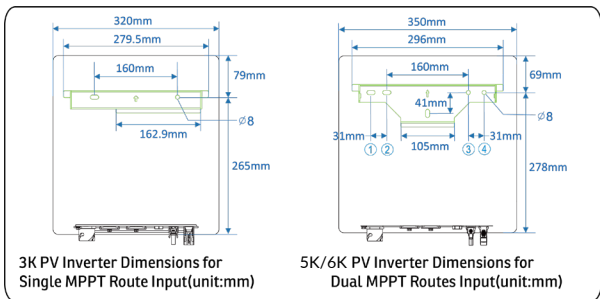

Figure 4.10 Determine the positions for drilling holes (unit: mm)

Step 3 Level the hole positions using a level gauge, and mark the hole positions using a marker (as shown in **Figure 4.11**).

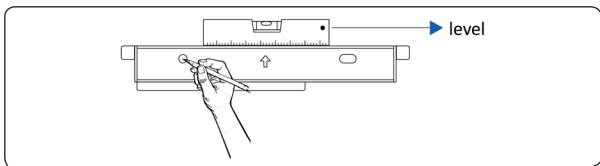

Figure 4.11 mark the hole positions using a marker

Step 4 Drill holes using a hammer drill and install expansion bolts, as shown in **Figure 4.12**.



DANGER

Before drilling the hole on the wall, ensure no damage on the electric wire and/or water pipe inside the wall.

a. Drill a hole in a marked position to a depth of 60 mm using a hammer drill with a $\Phi 10$ mm bit.

b. Partially tighten an expansion bolt, vertically insert it into the hole, and knock the expansion bolt completely into the hole using a rubber mallet.

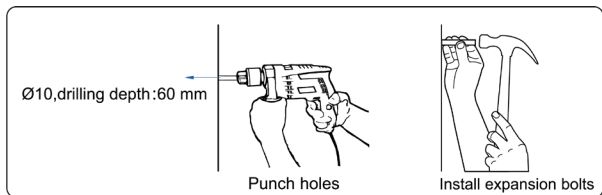

Figure 4.12 Punch holes and install expansion (unit: mm)

Step 5 Align the rear panel with the holes, insert expansion bolts into the holes through the rear panel, and tighten the expansion bolts to a torque wrench (torque 2-2.5 N·m), as shown in **Figure 4.13**.

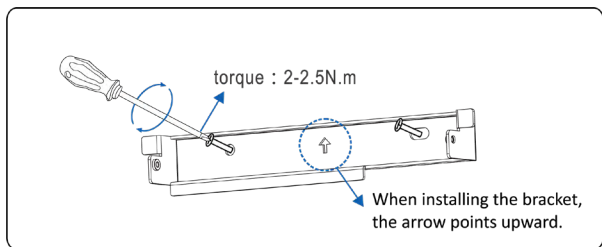

Figure 4.13 Installing the real panel

4.6 Installing the inverter

Follow below procedures:

Step 1 Hold the handles at both sides of the inverter and then lift and stand the inverter.

Step 2 Mount the inverter on the rear panel and keep them aligned with each other, as shown in **Figure 4.14**.

Step 3 Tighten the two hexagon screws at the both sides of the inverter to a torque of 1.2N.m and 3N.m respectively. Screw specs for 3K and 5K/6K are M4 and M6 respectively, as shown in **Figure 4.14**.

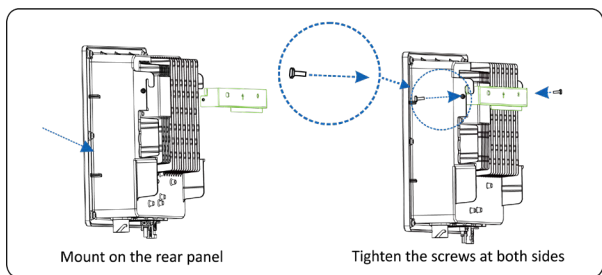

Figure 4.14 Securing the inverter

**DANGER**

Before performing any electrical connections, ensure that both DC and AC Switches are OFF. Otherwise, fatal injury can occur due to the high voltage caused from AC and DC cables.

5.1 Connecting Protection Ground (PGND) Cables

5.1.1 Preparation

The ground cable and OT terminals have been prepared.

- a. Ground cable: Outdoor copper-core cables with a cross sectional area of 4 mm or more are recommended.
- b. OT terminal: OT6~4.

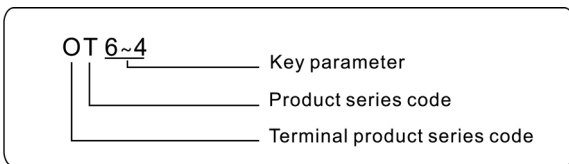
**NOTE!**

Good grounding for the inverter helps resist the impact of surge voltage and improve the EMI performance. Connect the PGND cable before connecting the AC power cables, DC power cables, and communication cables.

NOTE!

It is recommended that the ground cable be connected to a nearby ground position. For a system with multiple inverters connected in parallel, connect the ground points of all inverters to ensure equipotential connections.

5.1.2 Wiring Procedures

Step 1 Remove an appropriate length of the insulation layer from the PGND cable using a wire Stripper; the length is a little bit longer than that of OT terminal's crimping end by 2mm~3mm, as shown in **Figure 5.1**.

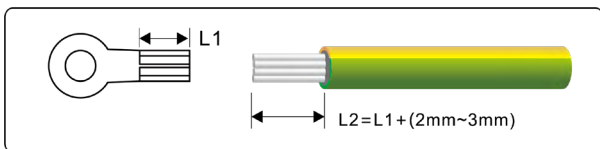

Figure 5.1 Stripped length (unit: mm)

Step 2 Insert the exposed core wires into the crimping areas of the OT terminal and crimp them using hydraulic pliers, as shown in **Figure 5.2**.

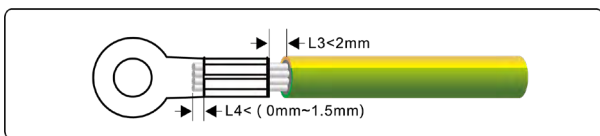

Figure 5.2 Crimping a cable (unit: mm)

Step 3 Remove the ground screws from the ground points, as shown in **Figure 5.3**.

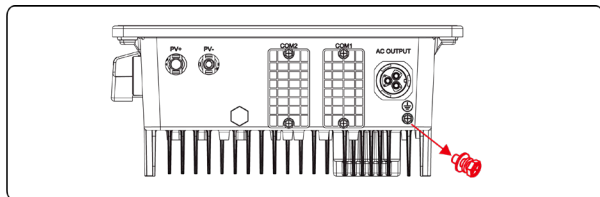

Figure 5.3 Crimping a cable (unit: mm)

Step 4 Secure the PGND cable (done by step 1 & 2) using the ground screw and tighten the screw using a socket wrench (torque 1.2 N·m), as shown in **Figure 5.4**.

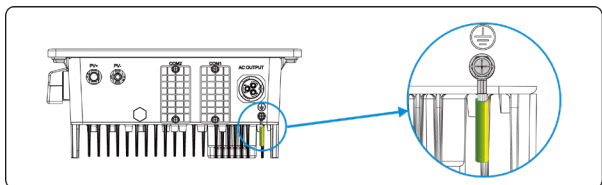

Figure 5.4 Secure the PGND cable

5.2 Connecting AC Output Cables

5.2.1 Preparation

The AC power cable and AC terminals have been prepared.

a. AC power cable: Outdoor copper-core cables are recommended. **Table 5.1** describes the specifications.

Inverter Model	Cable type	Cross-sectional Area(mm ²)		Cable Outer Diameter mm	
		Range	Recommended Value	Range	Recommended Value
3K	outdoor cable	4~6	4	10~14	14
5K/6K	outdoor cable		6		

Table 5.1 AC output cable specifications

b. The recommended specifications of circuit breaker are shown in the table below.

Inverter Model	Recommended Value
3K	25A
5K	32A
6K	40A

Table 5.2 Circuit breaker specifications





 **WARNING**

An independent circuit breaker must be installed on the AC side of each inverter to ensure that the inverter can be safely disconnected from the power grid.

 **WARNING**

Do not connect loads between the AC output terminals of the inverter and circuit breaker.

5.2.2 Procedure of Connecting AC Cables

 NOTE	There are four types of AC terminals in use (choose one from four). Please refer to the real object in the deliverables.		
 in usual	 optional	 optional	 optional

Step 1 It is recommended to use outdoor dedicated cables with multiple copper cores.

Remove an appropriate length of the jacket and insulation layer from the AC output cable using a wire stripper.

Step 2 Lead the AC cable through the rubber nut, seal and so on. Please refer to the following picture **number 2** below.

Step 3 Tighten three screws and ensure each screw cap does not exceed the surface, then install AC connector as shown picture **number 3-A** below.

Step 4 Plug the AC connector into the inverter.

NOTE!

There are four types of AC terminals. Please refer to the object in the delivery. **Type A** is in usual. Whether you use type **3-A**, **3-B/C/D**, tighten the waterproof nut to avoid loosening. Take **type 3-A** as example in the following steps.

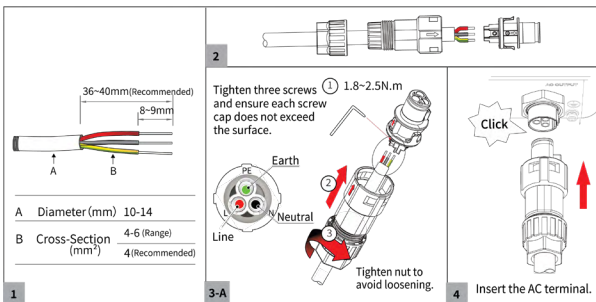

The wiring process of **type B**, **type C**, **type D** are shown as below.

Note: Whether you use type A, B, C or D, tighten the waterproof nut to avoid loosening.

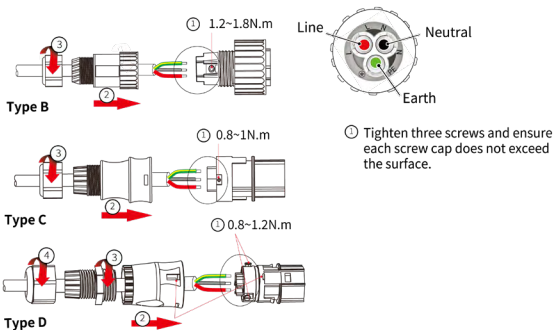

3-B/C/D

NOTE!

Ground, neutral, and line wires must correspond to G, N, and L terminals of AC connectors respectively. Otherwise, the faulty connection will lead to the inverter performance failure.

Step 5 After the AC terminal is connected, Install **protection sleeve (optional)** as shown in picture **number 5** below.

When you choose **type B**, the protection sleeve is **optional**.

Step 5 is only applicable to **type B** AC terminal when equipped with protection sleeve.

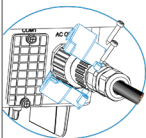

After the **type B** terminal is connected, install protection sleeve on the connection position, and tighten the screws to prevent the terminals from slipping off.

5

5.3 Connecting the PV Strings

DANGER

PV Strings connection requires the following prerequisites; otherwise, an electrical shock can occur.

PV modules generate electric energy when exposed to sunlight and can create an electrical shock hazard. Therefore, when connecting the PV modules, shield them with opaque cloth.

Before connecting DC input power cables, ensure that the voltage on the DC side is within the safe range and that the DC SWITCH on the inverter is OFF. Otherwise, high voltage may result in electric shock.

When the inverter is grid-tied, it is not allowed to maintain DC input power cables, such as connecting or disconnecting a string or a module in a string. Only after the inverter enters in shutdown mode, maintenance of DC input power cables is allowed.

WARNING

Grounding of the PV Strings requires the following prerequisites; otherwise, a fire can occur.

PV modules connected in series in each PV string must be of the same specifications.

The maximum open-circuit voltage of each PV string must be always lower than or equal to its permitted range.

The maximum short circuit current of each PV string must be always lower than or equal to its permitted range.

The positive and negative terminals of PV modules must be connected to the positive and negative DC input terminals of the inverter respectively. negative DC input terminals of the inverter respectively.

During the installation of PV strings and the inverter, the positive or negative terminals of PV strings cannot be connected with short circuit.

5.3.1 Preparation

Route collecting for the installation of PV strings and inverter:

Inverter Model	Number of Input Route
3K	Connected to route 1
5K/6K	Connected to route 2

PV Strings DC input cable and connectors have been prepared; Table 5.2 lists the recommended outdoor copper-core DC input cable specifications.

Inverter model	Cable Type	Cross-sectional Area(mm ²)		Cable OuterDiameter(mm)
		Range	Recommended Value	Range
3K	Common PV cables in the industry (model:PV1-F)	4~6	4	5~8
5K/6K				

Table 5.3 Recommended DC input cable recommended specifications

Connectors of PV Strings: Positive and negative DC input connectors are used, as shown in **Figure 5.8** and **Figure 5.9**.

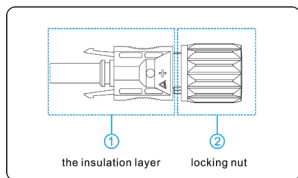

Figure 5.8 Positive connector compositions

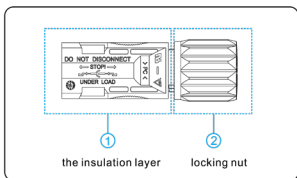

Figure 5.9 Negative connector compositions

NOTE!

Positive and negative metal connectors are packed with positive and negative connectors respectively when shipped out. After unpacking, keep the positive and negative ones separate to avoid confusion.

Procedures of connecting the PV Strings

Step 1 Remove an appropriate length of the insulation layer from the positive and negative power cables using a wire stripper, as shown in below Figure.

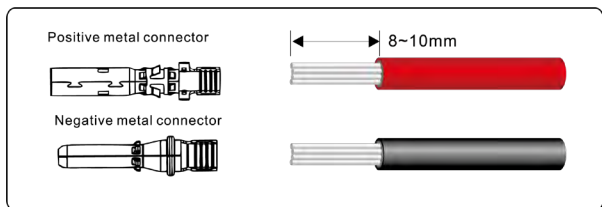

Figure 5.10 Removing insulation layer for DC cable (unit: mm)

Step 2 Insert the exposed areas of the positive and negative power cables into the metal terminals of the positive and negative connectors respectively and crimp them using a crimping tool, as shown in **Figure 5.11**.

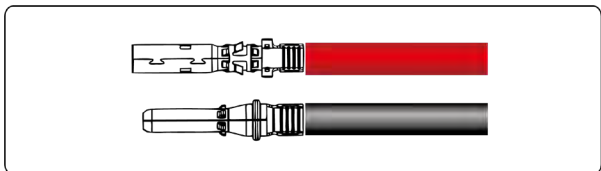

Figure 5.11 Crimping a metal connector

Step 3 Insert the crimped positive and negative power cables into the corresponding positive and negative connectors until a “click” sound is heard, as shown in **Figure 5.12**.

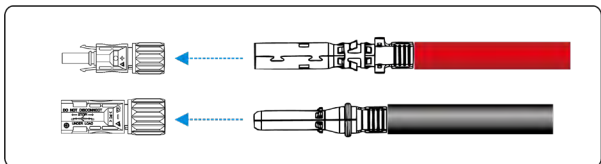

Figure 5.12 Connecting positive and negative connectors

Step 4 Tighten the locking nuts on the positive and negative connectors using a removal wrench, as shown in **Figure 5.13**.

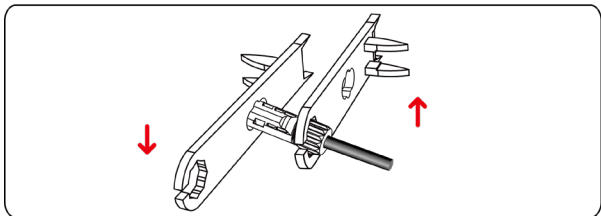

Figure 5.13 Locking connectors

Step 5 Measure the voltage of every route Strings using a multimeter. Ensure that the polarities of the DC input power cables are correct, as shown in **Figure 5.14**.

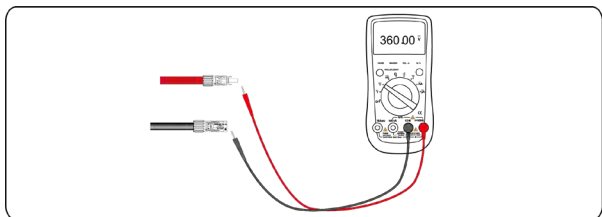

Figure 5.14 Checking the voltage of every route Strings

Step 6 Insert the positive and negative connectors into their corresponding terminals of the inverter until a “click” sound is heard, as shown in **Figure 5.15**.

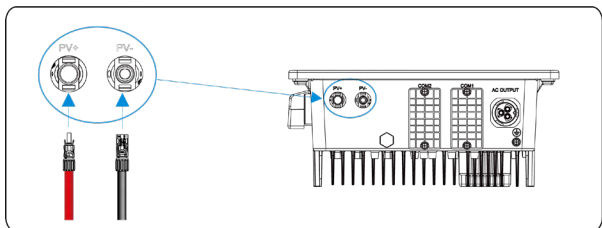

Figure 5.15 Connecting to the inverter

Step 7 After connecting the PV strings, ensure that all connectors are in position by checking for resistance when a slight pull is applied.

5.4 Connecting Communication Cables

5.4.1 Communication Mode Description

You can use the following communication modes to implement communication: Bluetooth, WIFI, GPRS and RS485 all of which are described as follows.

Bluetooth Module

You can turn on the Bluetooth function of the mobile phone, and set parameters and monitor data of the inverter through the mobile APP. For details about operation, refer to APP User Manual.

WIFI & GPRS & RS485 Modules

Following figure show inverter's interface to connect WIFI, GPRS and RS485 accessory, please refer user manual of accessory for connecting method and its setting.

Module	Function description
WIFI	WIFI module implements communication with Cloud server through wireless network to monitor PV inverter's data status. For more details, refer to WIFI Product Application Manual.
GPRS	GPRS module communicates with Cloud server through a mobile phone to monitor PV inverter's data status. For more details, refer to GPRS Product Application Manual.
RS485	RS485 switching module monitors PV inverter's data status through collecting and uploading data to Cloud server. For more details, refer to RS485 switching Product Application Manual.
NOTE	You can choose and buy WIFI/GPRS/RS485 communication modules from the company. The baud rate supported by RS485: 9600BPS

Table 5.4 WIFI & GPRS & RS485 Modules Description

5.5 Power limit (optional)

5.5.1 Wiring diagram of Inverter+CT

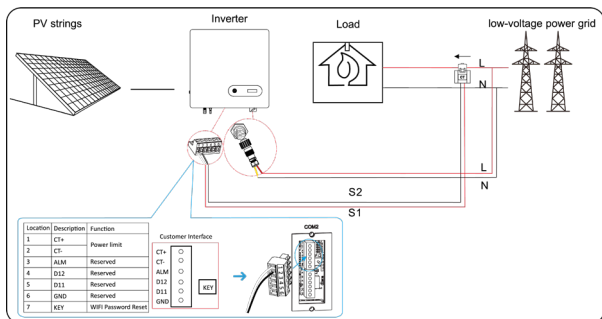

Figure 5.16 Wiring diagram of Inverter+CT

Power Limit	Power Limit
Power limit function Disable	Power limit function CT sensor
Power limit mode Meter on Grid	Power limit mode On Grid
Power limit CT ratio 1000:1	Power limit CT ratio 1000:1
Maximum feed in grid power(W) 0	Maximum feed in grid power(W) 0
Digital Power Meter Type Unknown	Digital Power Meter Type Unknown

Figure 5.17 Settings via APP

- Power limit function set to “CT sensor”
- Set the CT position base on the meter installed on load or on grid
- Set maximum feed-in grid power if needed
- Set Power limit CT ratio

5.5.2 Wiring diagram of Inverter+Meter

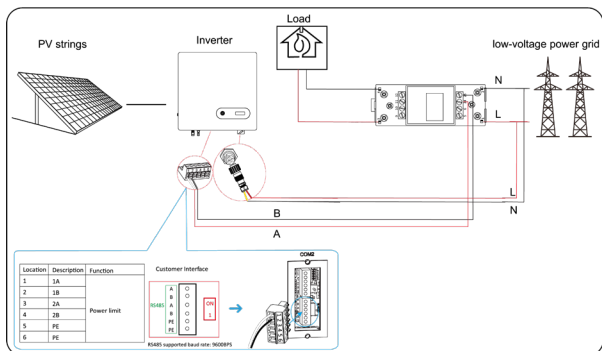

Figure 5.18 Wiring diagram of Inverter+Meter

Power Limit	Power Limit
Power limit function Disable	Power limit function Digital Power Meter
Power limit mode Meter on Grid	Power limit mode On Grid
Power limit CT ratio 1000:1	Power limit CT ratio 1000:1
Maximum feed in grid power(W) 0	Maximum feed in grid power(W) 0
Digital Power Meter Type Unknown	Digital Power Meter Type DDSU666

Figure 5.19 Settings via APP

- Set the “Power limit function” to “Digital Power Meter”
- Set the Digital Power Meter Type
- Set the meter position base on the meter installed on load or on grid
- Set maximum feed-in grid power if needed
- Set “Power limit CT ratio” only when using inverter+CT

When “Power limit function” is set to “Digital Power Meter”, the RS485 of inverter will change to a Host that will communicate with digital meter using Modbus-RTU protocol (9600 BPS, 8 data bit, 1 stop bit, no parity data format) through communication address 1. Please make sure that the meter is set to Modbus-RTU, 9600, 8-N-1 with address 1. For details of digital meter setting operation, please refer to the meter user manual.

5.6 Installation Verification

Check the following items after the inverter is installed according to **Table 5.4**.

1. No other objects are put on the PV inverter.
2. All screws, especially the screws used for electrical connections, are tightened
3. The PV inverter is installed correctly and securely.
4. Ground, AC, DC, and Communications cables are connected tightly/ correctly and securely.
5. Check and ensure there is no open circuit or short-circuits at AC and DC terminals using multimeter.
6. Waterproof connectors at AC terminals and RS485 ports are plugged with waterproof plugs tightly.
7. Covers at AC terminals are tightened.
8. Idle terminals are sealed.
9. All safety warning symbols are intact and complete on the inverter.

Table 5.5 Self-check items after installation

5.7. Parallel inverter mounting

The parallel mounting will be conducted in accordance with the diagram: each inverter will be connected to the grid and it will have its own row of PV panels, as well as CT sensor or Smart Meter. Keep in mind that the electricity amount fed to the grid is the sum of each inverter's yield, so consider making the correct configuration in the Power Control section. All the procedures explained previously about a single inverter mounting are valid for parallel mounting too.

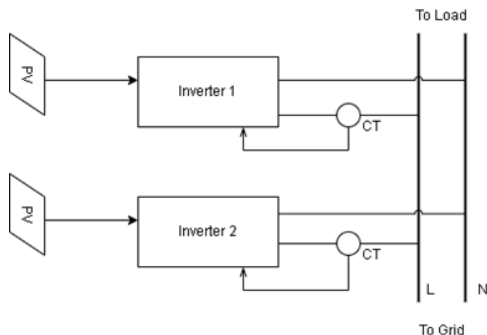

6 System Operation

6.1 Powering ON the Inverter

Step 1: Switch ON the AC circuit breaker.

Step 2: If the inverter has a switch, turn the switch to "ON" state.

Step 3: Observe statuses of LED indicator lights on the inverter according to **Table 7.1**.

NOTE!

When LED status lights display the inverter has entered grid-connecting, it means the inverter is operating well. Any query during operating the PV inverter, call your dealer.

6.2 Powering OFF the Inverter

Step 1: Run a shutdown command on the mobile APP.

Step 2: Switch off the circuit breaker at AC terminal.

Step 3: If the inverter has a switch, turn the switch to “OFF” to observe.

WARNING

After the inverter is power off, the remaining electricity and heat may still cause electrical shock and body burns. Maintenance of the inverter shall begin ten minutes after the power-off.

7 User Interface

Display screen of inverter is composed of LED indicator (LCD is optional for some models). LED contains three color states, blue, green and red respectively. For more details, refer to **Table 7.1** HMI specification definition.

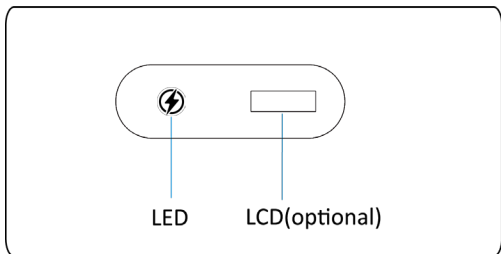

NOTE!

You can view & set data of the inverter through inverter APP. For details about operation, refer to APP User Manual. APP User Manual is available for free from www.nJoy.global website.

7.1 HMI specification definition

LED Indicator	Description	Status
Blue led	Standby	blink(slowly)
	Normal status	on
Green led	Limited power operation	on
Red led	Refer to the table below	
Warning Definition	LCD Display	Status
Grid over voltage	A0 Grid OV	Red led blink(slowly)
Grid under voltage	A1 Grid UV	Red led blink(slowly)
Grid absent	A2 Grid Loss	Red led blink(slowly)
Grid over frequency	A3 Grid OF	Red led blink(slowly)
Grid under frequency	A4 Grid UF	Red led blink(slowly)
PV over voltage	B0 PV OV	Red led blink(quickly)
Insulation resistance abnormal	B1 Imp abn	Red led blink(quickly)
Leakage current abnormal	B2 Lkge abn	Red led blink(quickly)
Control power abnormal	C0 Powerfail	Red led on
Arc fault	C1 Arc fault	Red led on
Dc bias current abnormal	C2 OP Dc OC	Red led on
Inverter relay abnormal	C3 RLY abn	Red led on
Inverter over temperature	C5 SYS OT	Red led on
Leakage current HCT abnormal	C6 LkgCT abn	Red led on
System fault	C7 SYS err	Red led on

Fan fault	C8 FAN lock	
DC link under voltage	C9 Bus UV	Red led on
DC link over voltage	CA Bus OV	Red led on
Internal Communications fault	CB COM err	Red led on
Software version incompatibility	CC FW Incomp	Red led on
EEPROM fault	CD EEP err	Red led on
Sampling inconsistency	CE Inconsis	Red led on
Boost circuit abnormal	CG Bst abn	Red led on
Remote off	CN RMT OFF	

Table 7.1 HMI specification definition

7.2 LCD automatic-page-turning display

Mode	Display content	Note
The LCD display interface of the inverter standby state is shown in the following sequence:	Astris 5K Ver 01.00.00	Model name Version
	Udc 350/360V Vac 220V	PV voltage AC voltage
	Today 80kWh Etot 8000kWh	Today Energy Total Energy
	A0 Grid OV B1 Imp abn	Warning
The LCD display interface for countdown of inverter gridconnected is shown in the right picture:	Starting 60s	Start counter down

The LCD display interface of the inverter grid-connected state is shown in the figure on the right:	Pac 5000W Today 50kWh	Output power Today Energy
	Etot 8000kWh Htot 80000hr	Total Energy Total Hours
	Vdc 350/350V Idc 8/8A	PV voltage PV current
	Vac 220V Iac 28A	AC voltage AC current
	08:00 2018-08-08	hour:minute year/month/day

Table 7.2 LCD automatic-page-turning display

8 Maintenance



WARNING

Before maintaining and commissioning inverter and its peripheral distribution unit, switch off all the charged terminals of the inverter and wait at least 10 minutes after the inverter is powered off.

8.1 Routine Maintenance

Check Item	Check Content	Maintain content	Maintenance Interval
inverter output status	Statistically maintain the status of electrical yield, and remotely monitor its abnormal status.	NA	Weekly

PV inverter cleaning	Check periodically and ensure that the heat sink is free from dust and blockage.	Clean periodically the heat sink.	yearly
PV inverter running status	Check that the inverter is not damaged or deformed. Check for normal sound emitted during inverter operation. Check and ensure that all inverter communications is running well.	If there is any abnormal phenomenon, replace the relevant parts.	monthly
PV inverter Electrical Connections	Check and ensure that AC, DC, and communication cables are securely connected; Check and ensure that PGND cables are securely connected; Check and ensure that cables are intact and free from aging;	If there is any abnormal phenomenon, replace the cable or re-connect it.	Semiannually

Table 8.1 Maintenance checklist and interval

8.2 Inverter Troubleshooting

When the inverter has an exception, its basic common warning and exception handling methods are shown in the table 8.2.

Alarm Name	Causes	Measures Recommended
Grid Over Voltage	The grid voltage exceeds its allowable range.	<ol style="list-style-type: none"> 1. If the alarm occurs accidentally, the power grid may be abnormal accidentally. No extra action is needed. 2. If the alarm occurs repeatedly, contact the local power station. After receiving approval of the local power bureau, revise the electrical protection parameters setting on the inverter through mobile APP. 3. If the alarm persists for a long time, check whether the AC circuit breaker/AC terminals is disconnected or not, or if the grid has a power outage.
Grid Under Voltage		
Over Frequency		
Under Frequency		
PV Over Voltage	PV modules input voltage exceeds the inverter's allowable range.	Check the number of PV modules and adjust it if need.
PV Under Voltage	PV modules input voltage is under the inverter's defaulted protection value.	<ol style="list-style-type: none"> 1. When sunlight intensity weakens, PV modules voltage decreases. No action is needed. 2. If such phenomena occur when sunlight intensity does not weaken, check if there is short circuit, open circuit etc. in the PV strings.
Insulation Resistance Abnormal	A short circuit exists between PV strings and protection ground. PV strings are installed in a long-term moist environment.	<ol style="list-style-type: none"> 1. Check the insulation resistance against the ground for the PV strings. If a short circuit has occurred, rectify the fault. 2. If the insulation resistance against the ground is less than the default value in a rainy environment, set Insulation resistance protection on APP.

Residual Current Abnormal	The insulation resistance against the ground at the input side decreases during the inverter operation, which causes excessively high residual current.	<ol style="list-style-type: none"> 1. If the alarm occurs accidentally, possibly the external circuits are abnormal accidentally. The inverter automatically recovers to the normal operating status after the fault is rectified. 2. If the alarm occurs repeatedly or lasts a long time, check whether the insulation resistance against the ground of PC strings is too low.
PV Strings Abnormal	PV strings have been obscured for a long time. PV strings are aging	<ol style="list-style-type: none"> 1. Check whether the PV string is obscured 2. If the PV string is clean and not obscured, check whether the PV modules are aging or deteriorated.
PV Strings Reverse	The cables of PV strings are connected reversely during the inverter installation.	Check whether the cables of PV strings are correctly connected. If they are connected reversely, reconnect the cables.
BUS Under Voltage	Abnormal internal energy control imbalance has been triggered by the PV Strings/grid sharp change of working conditions	<ol style="list-style-type: none"> 1. If the alarm occurs occasionally, the inverter can automatically recover to the normal operating status after the fault is rectified. 2. If the alarm occurs repeatedly, contact your dealer for technical support.
BUS Over Voltage		
Invert Module Fault		
BOOST Fault		
EEPROM Fault	EEPROM Component damaged	Replace the monitoring board.
Zero power generation and Yellow alarm light illuminating in remote monitor system	Communications outage	If modem or other data logger is used, please reboot it; if still does not work after rebooting, contact your dealer.

remote monitor displays zero power generation	Communications outage	If modem or other data logger is used, please reboot it; if still does not work after rebooting, contact your dealer.
remote monitor displays no output voltage	Output switch tripping	Check if DC switch is damaged, and if not, switch it to ON. If it still doesn't work, contact your dealer.
Inverter off grid	1. Power grid fault; 2. DC switch tripping	1. Wait till power is restored; 2. Turn DC switch to ON, and if DC switch trips a lot, contact your dealer.
Arc fault detection	Electrical Arcs	a. Check whether the circuit of the solar module is abnormal, including wire integrity, joint tightness. b. After the faults removal, turn off the AC/DC switch and start the inverter again, or click AFD Reset function on the APP page to eliminate the alarm.

Table 8.2 Common troubleshooting measures

NOTE!

If you cannot clear the preceding alarm according to the measures recommended, contact your dealer in a timely manner.

8.3 Removing the Inverter

Perform the following procedures to remove the inverter:

Step 1: Disconnect all cables from the inverter, including communications cables, DC input power cables, AC output power cables, and PGND cables.

NOTE!

When removing DC input connector, insert the removal wrench to the bayonet, press the wrench down, and take out the connector carefully.

Step 2: Remove the inverter from the rear panel.

Step 3: Remove the rear panel.



WARNING

Before removing DC input connector, double check and ensure DC input switch is turned OFF to avoid inverter damage and personal injury.

The PV inverter and its packing case are made from environment-friendly materials. If the inverter service life has expired, do NOT discard it with household garbage; dispose the inverter in accordance with local environmental laws and regulations.



Disposal of Old Electrical & Electronic Equipment

(Applicable in the European Union and other European countries with separate collection systems)

This symbol on the product or on its packaging indicates that this product shall not be treated as household waste.

Instead it shall be handed over to the applicable collection point for the recycling of electrical and electronic equipment.

By ensuring this product is disposed of correctly, you will help prevent potential negative consequences for the environment and human health, which could otherwise be caused by inappropriate waste handling of this product.

The recycling of materials will help to conserve natural resources.